

Burnerpanel frame work and platform with stairs are optional.
 Transportmass: ±3,4 t
 Heated surface: 59m²
 Watercontent: 4,5m³

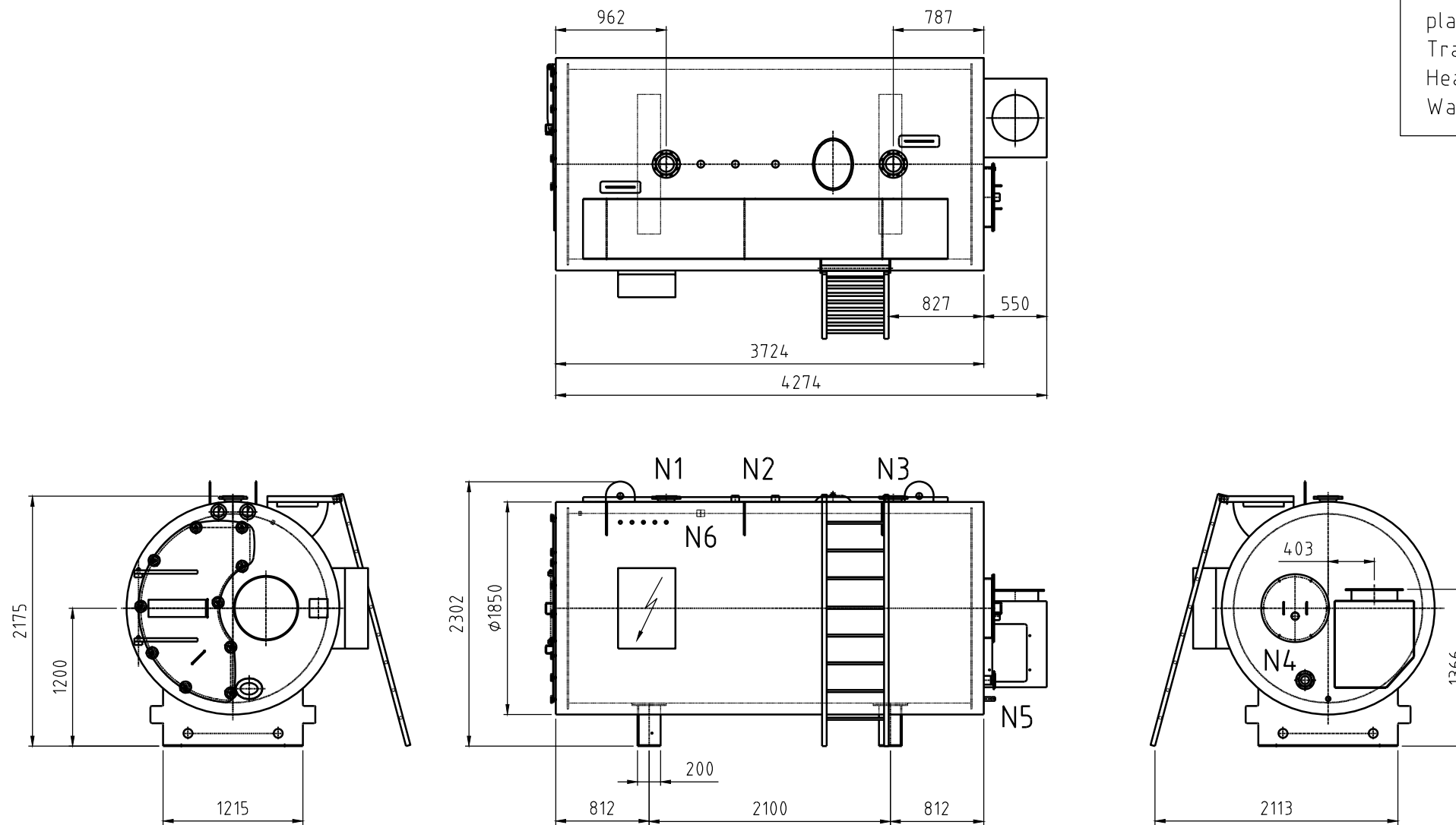

In case of an order exact boiler weight and measurements will be given on request. Subject to modifications.

NOZZLE CHART (DIN)			
	NAME	DN	PN
N1	SUPPLY	125	6
N2	SAFETY VALVES (2x)	2"	-
N3	RETURN	125	6
N4	SHUNT	65	6
N5	DRAIN	1"	-
N6	LOW WATER LEVEL	2"	-

Index	Date	Drawn	Checked	Modifications	Size	Scale
				Drawing number: 30550800.HKB	A3	1:40
				Title: LNE COMPACT 1.5	Modification: 1	Projection:
HKB Ketelbouw B.V. Rijnaakkade 16 5928 PT Venlo Tel: 0031-77-7504000 www.hkb-ketelbouw.nl				Project number: -	Drawn: NG	Date: 24-04-2014
				Customer: TK-Top Boiler	Checked: RH	Date: 24-04-2014

The information contained in this drawing is the sole property of HKB Ketelbouw B.V.
 Any reproduction in part or as a whole without the written permission of HKB Ketelbouw B.V. is prohibited.



Woudeselaan 22, 2635 CH Den Hoorn, Nederland
 Telefoon: +31(0)15-2125547 Fax: +31(0)15-2840505
 E-Mail: info@tk-topboiler.nl